

Keep this  
manual onboard!



# User Manual

Including Installation For Remote Controls  
RCT-20E, RCT-21E, RCT-22E, RCT-23E  
RCR-2E, RCRS-2E



## SLEIPNER GROUP

P.O. Box 519  
N-1612 Fredrikstad  
Norway  
[www.sleipnergroup.com](http://www.sleipnergroup.com)

DOCUMENT ID: 2955

REVISION: I2

DATE: 2023

LANGUAGE: EN



To download your language go to [www.sleipnergroup.com](http://www.sleipnergroup.com)

# Contents

## User Manual

|   |       |
|---|-------|
| General Operation Consideration and Precaution Guidelines ..... | 3     |
| Remote Control Kits .....                                       | 4     |
| Remote Layout & Functions .....                                 | 5     |
| User Operation.....   | 6 - 7 |
| Programming Additional Transmitters/ Remote Controls.....       | 8 - 9 |
| Transmitter Installation and Battery Replacement.....           | 10    |
| Transmitter LED Operation and Alarm Indication .....            | 11    |
| Receiver LED Indicator .....                                    | 11    |
| S-Link Transmitter LED Operation and Alarm Indication .....     | 11    |

## Installation Manual

|   |         |
|---|---------|
| Responsibility of the Installer .....       | 12      |
| Signals Considerations and Precautions..... | 12      |
| S-Link Receiver Installation .....          | 13      |
| Receiver Installation .....                 | 14      |
| Technical Specifications .....              | 15      |
| S-Link Technical Specifications .....       | 15      |
| Technical Wiring Diagram .....              | 16 - 19 |
| Output Signals Diagram.....                 | 20      |
| S-Link System Description .....             | 21      |
| Technical Wiring Diagram.....               | 22      |

**Service and Support..... 23**

**Product Spare Parts and Additional Resources..... 23**

**Warranty Statement..... 23**

**UK Declaration of Conformity .....** 24

**CE Declaration of Conformity.....** 25

## Products

RC-20E Remote control, complete kit for bow and stern thruster, EU  
RC-21E Remote control, complete kit for thruster and windlass, EU  
RC-22E Remote control, complete kit for dual windlass, EU  
RC-23E Remote control, complete kit for dual thruster and dual windlass, EU  
RCS-20E S-link Remote control, complete kit for bow and stern thruster, EU

RCT-20E Remote control transmitter bow and stern thruster, EU  
RCT-21E Remote control transmitter bow thruster and windlass, EU  
RCT-22E Remote control transmitter for dual windlass, EU  
RCT-23E Remote control transmitter dual thruster and dual windlass, EU  
RCR-2E Remote control receiver, EU  
RCRS-2E Remote control receiver S-link, EU



Sleipner Motor AS  
P.O. Box 519, Arne Svendsensgt. 6-8  
N-1612 Fredrikstad, Norway

MC\_0451

## **General Operation Consideration and Precaution Guidelines**

MC\_0444

### **For the operation of remote controls**

MC\_0443

**It is recommended that the remote transmitter is stored in a secured location to avoid operation by unintentional personnel and to ensure availability when operation is required. This could be achieved by mounting the holding bracket in a location on the bridge not easily accessible to children and other unauthorized personnel.**

- To reduce risk of dropping the remote transmitter in the water during operation it is recommended to wear the neck strap fastened to the remote control.

### **For the operation of thrusters**

MC\_0418

**Never use thrusters when close to objects, persons or animals in the water. The thruster will draw objects into the tunnel and the rotating propellers. This will cause serious injuries and damage the thruster.**

**Always turn the main power switch off before touching any part of the thruster. An incidental start while touching moving parts can cause serious injuries.**

**It is the owner, captains or other responsible parties full responsibility to assess the risk of any unexpected incidents on the vessel. If the thruster stops giving thrust for some reason while manoeuvring you must have considered a plan on how to avoid damage to persons or other objects.**

- Always turn the control device off when the thruster is not in use or when leaving the boat.
- When leaving the boat always turn off the main power switch for the thruster.
- Never use thrusters out of water without load.
- If the thruster stops giving thrust while running, there is possibly a problem in the drive system. You must immediately stop running the thruster and turn it off. Running the thruster for more than a few seconds without resistance from the propeller can cause serious damage to the thruster.
- If two panels are operated with conflicting directions at the same time the thruster will not run. If both are operated in the same direction, the thruster will run in this direction.
- If you notice any faults with the thruster switch it off to avoid further damage.
- The primary purpose of the thruster is to manoeuvre or dock the vessel. Forward or reverse speed must not exceed 4 knots when operated.

### **For Windlass systems**

MC\_0307

**Never use a windlass close to somebody in the water, an unexpected drop of the anchor can cause serious injuries.**

**It is the owner/ captain/ other responsible parties full responsibility to assess the risk of any unexpected incidents on the vessel.**

- Keep your distance to the windlass, the anchor line, anchor and anchor brackets during operation.
- While operating the anchor maintain observation of the rope or chain during handling.
- Ensure anyone using the windlass knows how to operate it.
- Be aware when the anchor are raised as it can bring unwanted debris up from the bottom, potentially damaging your boat. **(NB: If the windlass is straining as the anchor is raised, stop for a few seconds and let the boat gain up momentum before continuing the raise.)**
- If the anchor is stuck, release some anchor line/chain and attach it to a cleat before using the boat to pull the anchor free. The windlass is not designed for loads beyond the specified pull capabilities.
- The anchor **MUST ALWAYS** be secured to the boat while under way. Use the security line or other means to prevent unintentional anchor drop.
- Children must not operate the windlass.
- Careless use can cause damage or injury!
- Keep the engine running during windlass operation to ensure good battery capacity.
- Sleipner Motor AS is not responsible for damage or injury caused by the use of our windlass systems.
- While dropping anchor, do not push the "UP" button until the anchor is resting at the seabed.

The transmitters and receivers are sold as individual products and in kits. The content of the different kits is described below.

**Remote control kit RC-20U/E consists of:**

- Receiver: Part no. RCR-2U/E
- Transmitter (incl. Battery): Part no. RCT-20U/E
- Holding bracket for transmitter unit: Part no. RC-HOLDER

\*U For the USA configuration  
\*E For European configuration



**Remote control kit RC-21U/E consists of:**

- Receiver: Part no. RCR-2U/E
- Transmitter (incl. Battery): Part no. RCT-21U/E
- Holding bracket for transmitter unit: Part no. RC-HOLDER

\*U For the USA configuration  
\*E For European configuration



**Remote control kit RC-22U consists of:**

- Receiver: Part no. RCR-2U/E
- Transmitter (incl. Battery): Part no. RCT-22U/E
- Holding bracket for transmitter unit: Part no. RC-HOLDER

\*U For the USA configuration  
\*E For European configuration



**Remote control kit RC-23U consists of:**

- Receiver: Part no. RCR-2U/E
- Transmitter (incl. Battery): Part no. RCT-23U/E
- Holding bracket for transmitter unit: Part no. RC-HOLDER

\*U For the USA configuration  
\*E For European configuration



**Remote control kit RCS-20U/E consists of:**

- Receiver: Part no. RCRS-2U/E
- Transmitter (incl. Battery): Part no. RCT-20U/E
- Holding bracket for transmitter unit: Part no. RC-HOLDER

\*U For the USA configuration  
\*E For European configuration



# Remote Transmitter

**RCT-20(U/E)** \*U For the USA configuration  
\*E For European configuration



**RCT-21(U/E)** \*U For the USA configuration  
\*E For European configuration



**RCT-22(U/E)** \*U For the USA configuration  
\*E For European configuration

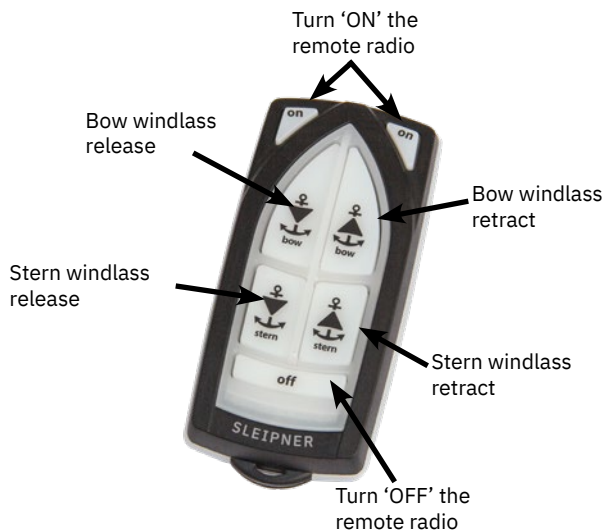

**RCT-23(U/E)** \*U For the USA configuration  
\*E For European configuration



# Receiver

**RCRS-2(U/E)** \*U For the USA configuration  
\*E For European configuration



**RCR-2(U/E)** \*U For the USA configuration  
\*E For European configuration



**! Please refer to the graphic for special considerations relating to your model !**

The following is an operation guide to ALL Sleipner control products. Ensure to familiarise yourself with the functionality and operation of your specific control device.

**Take time to practice operation in open water to become familiar with the thruster and to avoid damages to your boat or people.**

## General operation

1. Turn on the main power switch for the bow thruster. *(NB: Always turn off the main power switch when not on-board.)*
2. Turn on the control panel by pushing the/ both "ON" button(s) on the original Sleipner panel simultaneously.  
\*Turn off the control panel by pushing the "OFF" button
3. To Turn the bow/ stern in the desired direction:

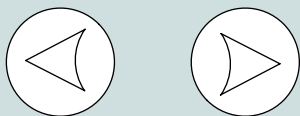

### Button control panels

For button control, push the button in the corresponding direction you wish the bow/ stern to move.

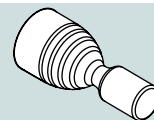

### Joystick control panels

For joystick control, move the joystick in the direction you wish the bow/ stern to move.

*(NB: If equipped for proportional control move the joystick equivalent to the amount of thrust you intend to receive.)*

\* For other controls like foot switches or toggle-switches please refer to that products user manual for detailed operational use.

## Hold functionality

If equipped with 'hold' functionality push the button in the corresponding direction you wish the thrusters to engage a holding pattern:

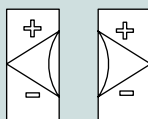

### Hold Button

+ or -

Will increase or decrease the holding force output of the thrusters

## Operating a combined bow and stern thruster

The combination of a bow and stern thruster offers total manoeuvrability to move the bow and the stern separately from each other or in unison. This enables the boat to move sideways in both directions or turn the boat around a 360° axis while staying stationary.

## Remote controls

The remote control design reflects the vessel for orientation guidance. Be aware of the remote control orientation during operation.

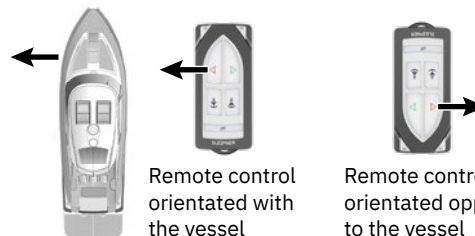
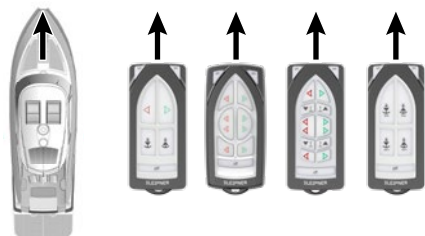

Remote control orientated with the vessel

Remote control orientated opposite to the vessel

## Drift

Depending on the sideways speed of the bow/ stern, you must disengage the control device shortly before the vessel is in the desired position.

*(NB: Be aware the boat will continue to move after disengaging the thruster control.)*

**At any significant cruising speed (+1-2 kn) the side thruster will have little effect to steer the vessel.**

Activating the bow thruster



Activating the stern thruster



Activating both bow and stern thruster to push the boat sideways



Activating both bow and stern thruster to rotate the boat on axis



Activating lowers Anchor/Windlass



Activating raises Anchor/Windlass



**! Please refer to the graphic for special considerations relating to your model !**

The original transmitter and receiver have the same factory pre-set code so that no programming is necessary. When additional transmitters remote controls are to be used, the additional transmitters/remote controls have to be paired with the receiver.

1. Be sure that there is power on the receiver (Green status LED blinking) and that the transmitter that should be paired is off.
2. Push the Pair Button on the receiver to put the receiver in pairing mode (as shown above). Both red and green LED's should start to blink simultaneously.
3. Within 10s after the receiver pair button is pushed, set the transmitter in pairing mode by holding the off button and pressing both "ON" buttons at the same time, all the transmitter LED's turn on indicating that it is set in pairing mode. When a pairing signal is received from the receiver the transmitter LED's while turn off and the system is ready to be used. If no pairing signal received within 10s the transmitter will leave the pairing mode.
4. Additional transmitters/remote controls must be programmed according to step 2-3. You can pair up to 4 transmitters/remote controls.
5. To clear all transmitters/remote controls paired with the receiver hold the pair button on the receiver for approximately 10s until the red and green led stop blinking. When the LED's stop blinking release the pair button, the green led will again start to blink when the receiver has completed the reset process. The receiver is then ready to pair with up to four transmitters/remote controls. Take time to practice operation in open water to become familiar with the thruster and to avoid damages to your boat or people.



MG\_0197



**! Please refer to the graphic for special considerations relating to your model !**

The original transmitter and receiver have the same factory pre-set code so that no programming is necessary. When additional transmitters remote controls are to be used, the additional transmitters/remote controls have to be paired with the receiver.

1. Be sure there is power on the receiver (S-link status LED is blinking green or continuous green ) and the transmitter that should be paired is off.
2. Push the Pair Button on the receiver to put the receiver in pairing mode (as shown above). The LINK/ACT LED should start to blink.
3. Within 10s after the receiver pair button is pushed, set the transmitter in pairing mode by holding the off button and pressing both “ON” buttons at the same time, all the transmitter LED’s turn on indicating that it is set in pairing mode. When a pairing signal is received from the receiver the transmitter LED’s while turn off and the system is ready to be used. If no pairing signal received within 10s the transmitter will leave the pairing mode.
4. Additional transmitters must be programmed according to step 2-3. You can pair up to 4 transmitters.
5. To clear all transmitters paired with the receiver hold the pair button on the receiver for approximately 10s until the LINK/ACT LED stops blinking. When the LED stops blinking release the pair button. The receiver is then ready to pair with up to four transmitters.



MG\_0200

**! Please refer to the graphic for special considerations relating to your model !**

1. Open the transmitter case by removing the 3 torx screws.
2. Remove the battery by inserting a screwdriver or similar between battery and holder at point A and flip the battery out, taking care not to damage the battery grips at point B.
3. Insert the new battery (Type CR2032, 3V - Brand name recommended). Ensure to insert the battery with the positive pole up diagonally into the battery holder, ensuring that the edge of the battery is under the battery grips (B). Press the battery down until secured at point A.
4. Close the transmitter. Put the cover back in place, ensure that the rubber seal between remote upper and the lower part is located correctly. Place the 3 screws (remember sealing washer) in their recessed holes and tighten carefully.

### IMPORTANT

**Before working on the transmitter, deactivate the transmitter and the receiver (push "OFF" on the transmitter(s)) and turn off the power to the receiver as well as the thruster main switch.**

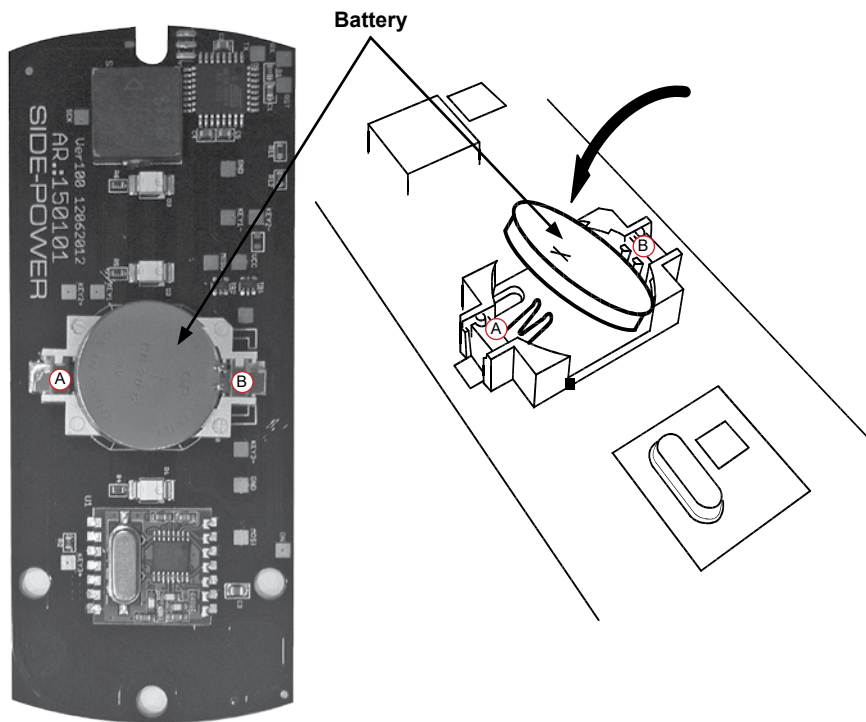

MG\_0194

| State             | LED status                           | Alarm status                        |
|-------------------|--------------------------------------|-------------------------------------|
| Transmitter ON    | The yellow LED's blink each second   | No sound                            |
| Buttons activated | The yellow LED's blink fast          | No sound                            |
| Pairing mode      | All LED's on                         | No sound                            |
| Connection lost   | Red LED is blinking once each second | 3 beeps from the buzzer each second |
| Low battery       | Red LED blink                        | One beep                            |

## Receiver LED Indicator

| State  | LED status                          |
|--|-------------------------------------|
| Power on the receiver and no transmitter connected           | Green LED is blinking               |
| Power on the receiver and at least one transmitter connected | Green LED on                        |
| No power to the receiver.                                    | Both LED is off                     |
| Receiver in pairing mode                                     | Both the red and green LED blinking |

## S-Link Receiver LED Indicator

| State                     | S-Link LED status |
|---------------------------|-------------------|
| No power to receiver      | OFF               |
| OK, S-Link Bus active     | Continuous GREEN  |
| No activity on S-Link bus | Blinking GREEN    |

| State                              | Link/ACT LED status |
|------------------------------------|---------------------|
| Remote off                         | OFF                 |
| At least one transmitter connected | ON                  |
| Device in pairing mode             | Blinking            |

# Installation Guide

**Failure to follow the considerations and precautions can cause serious injury, damage and will render all warranties given by Sleipner Motor as VOID.**

MC\_0411

## Responsibility of the Installer

MC\_0038

The installer must read this document to ensure necessary familiarity with the product before installation.

Instructions in this document cannot be guaranteed to comply with all international and national regulations. It is the responsibility of the installer to follow all applicable international and national regulations when installing Sleipner products.

The recommendations given in this document are guidelines ONLY, and Sleipner strongly recommends that advice is obtained from a person familiar with the particular vessel and applicable regulations.

This document contains general installation instructions intended to support experienced installers. If you are not skilled in this type of work, please contact professional installers for assistance.

If required by local regulation, electrical work must be done by a licensed professional.

Appropriate health and safety procedures must be followed during installation.

Faulty installation of Sleipner products will render all warranties given by Sleipner Motor AS.

When installing an S-Link™ system connect ONLY original Sleipner S-Link™ products or other authorized control equipment directly to the S-Link™ bus.

Connecting non-authorized third-party equipment, it must always be connected through a Sleipner supplied interface product.

Any attempt to directly control or connect into the S-Link™ control system without a designated and approved interface will render all warranties and responsibilities of all of the connected Sleipner products. If you are interfacing the S-Link™ bus by agreement with Sleipner through a designated Sleipner supplied interface, you are still required to install at least one original Sleipner control panel to enable efficient troubleshooting if necessary.

MC\_0105

## Signals Considerations and Precautions

MC\_0211

### IMPORTANT

Sleipner has developed remote controls with approval in the EU and US markets. However, it is the Importers responsibility to comply with all restrictions and legislation on radio signals in the country to which it is imported.

**! Please refer to the graphic for special considerations relating to your model !**

- Install the receiver minimum 1 meter (3ft) from high power cables and data communication cables or other sources of electrical interference, i.e. navigation instruments, radio communication devices, electric motors and generators.
- Install the receiver minimum 1 meter (3ft) above sea level.
- Install the receiver outside of shielded areas for radio signals, i.e. boxes made of metals or other material with shielding properties.
- Install the receiver in a dry environment, where no condensation can enter the unit. (The receiver assembly is not waterproof.)
- Mount the receiver using the four holes.
- The receiver is powered by the S-link cable.
- Connect the supplied wiring harnesses to the receiver unit according to the wiring diagram. Connect thrusters and windlasses to the appropriate connectors according to the diagram.
- For use with other windlass brands, connections must be determined by the installer according to the out put signals diagram.

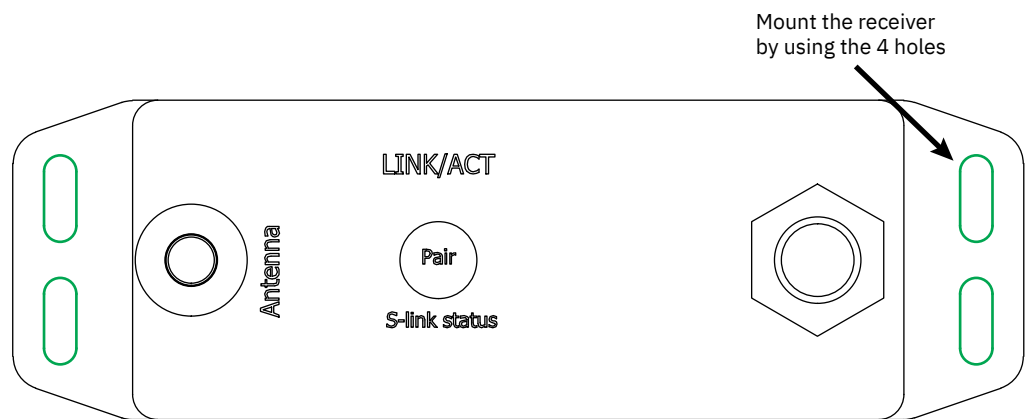

MG\_0193

**! Please refer to the graphic for special considerations relating to your model !**

- Install the receiver minimum 1 meter (3ft) from high power cables and data communication cables or other sources of electrical interference, i.e. navigation instruments, radio communication devices, electric motors and generators.
- Install the receiver minimum 1 meter (3ft) above sea level.
- Install the receiver outside of shielded areas for radio signals, i.e. boxes made of metals or other material with shielding properties.
- Install the receiver in a dry environment, where no condensation can enter the unit. (The receiver assembly is not waterproof.).
- Mount the receiver using the four holes.
- The receiver must have a separate power supply fitted with a 5 Amp fuse in the positive lead that has either a separate power switch or is shut off by the thrusters system main power switch. The receiver can not be powered by the thrusters/windlass control looms even if you find positive and negative lead there.
- Connect the supplied wiring harnesses to the receiver unit according to the wiring diagram. Connect thrusters and windlasses to the appropriate connectors according to the diagram.
- For use with other windlass brands, connections must be determined by the installer according to the out put signals diagram.

**NB: Max. load on the windlass signal output is 4A! If the windlass requires more than 4A, use extra control relay.**

#### IMPORTANT

**Remote receiver power supply negative lead must be connected to the thrusters' negative lead. Bow and stern thruster must have a common negative. Power to the thrusters must be switched off during installation!**



Mount the receiver  
by using the 4 holes

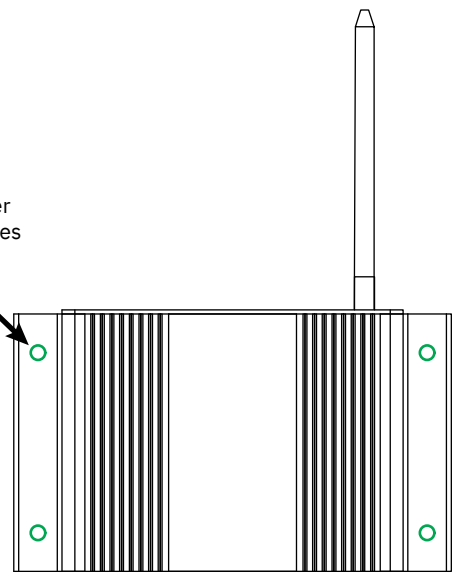

MG\_0193

## Transmitter/Receiver - Technical Specifications

MC\_0176

|                 | Transmitter                 | Receiver                |
|-----------------|-----------------------------|-------------------------|
| Power feed      | 1x3V battery (type: CR2032) | 12V or 24V power source |
| Frequency (MHz) | 868 MHz                     | 868 MHz                 |
| RF-power        | <10mW                       | <10mW                   |
| Operation temp. | -10°C / +55°C               | -10°C / +55°C           |
| HxWxD (mm)      | 107x47x21                   | 83x136x36               |
| Weight (g)      | 60                          | 275                     |
| Voltage         |                             | 8-30V                   |
| Standby power   |                             | <300mW                  |
| Load, max       |                             | 4A                      |

## S-Link Transmitter/Receiver - Technical Specifications

MC\_0176

|                 | Transmitter                           | Receiver                |
|-----------------|---------------------------------------|-------------------------|
| Power feed      | 1x3V battery (type: CR2032)           | 12V or 24V power source |
| Frequency (MHz) | 868 MHz                               | 868 MHz                 |
| Operation temp. | -10°C / +55°C                         | -10°C / +55°C           |
| HxWxD (mm)      | 107x47x21                             | 110x35x35               |
| Weight (g)      | 60                                    | 170                     |
| Voltage         |                                       | 8-30V                   |
| Operating range | 30m under normal operating conditions |                         |

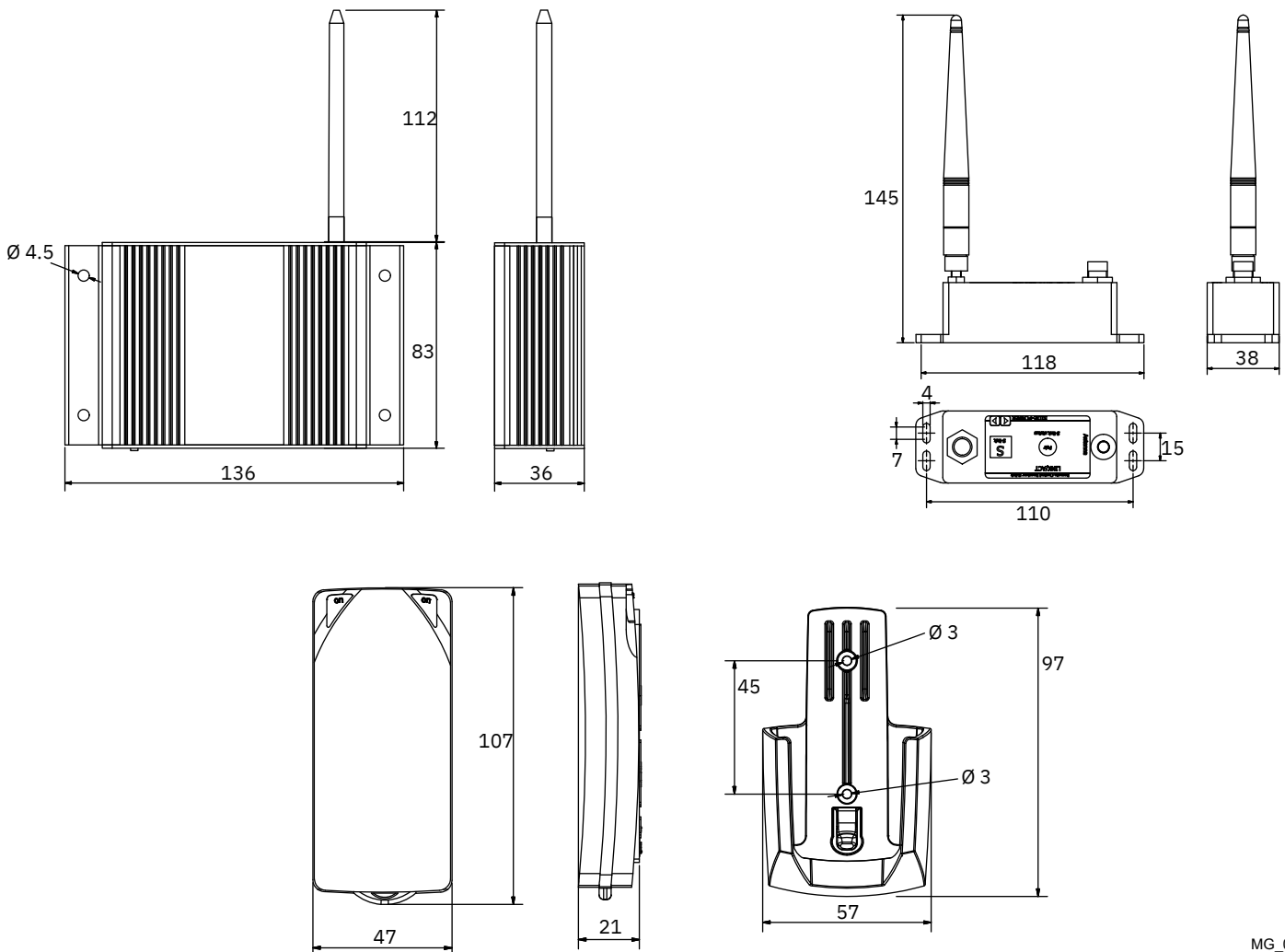

MG\_0191

# Technical Wiring Diagram



RCT-20(U/E)

**IMPORTANT**  
Cables/wires must be cable tied well.

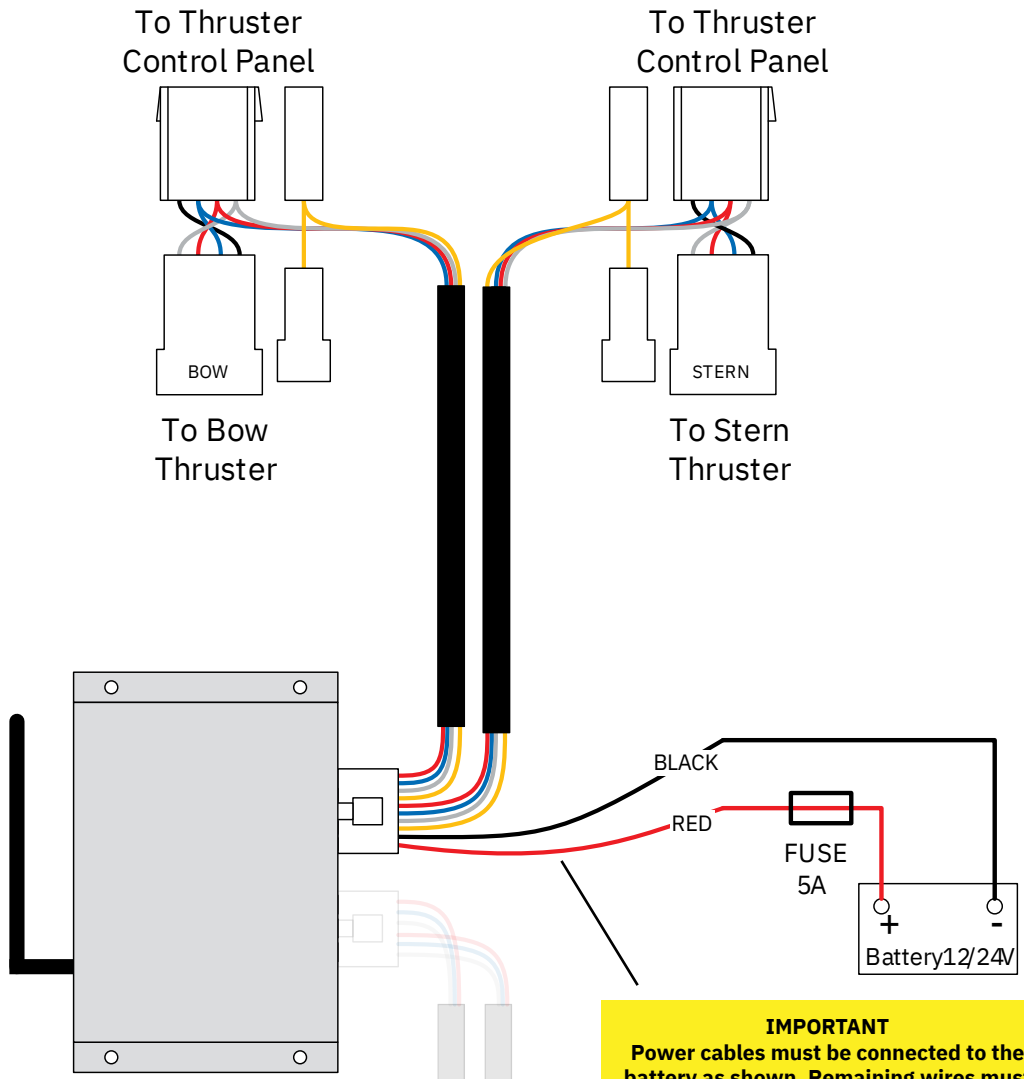

**IMPORTANT**  
Power cables must be connected to the battery as shown. Remaining wires must be cable tied well.

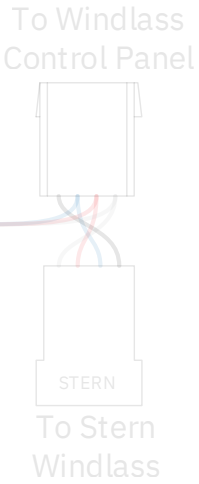
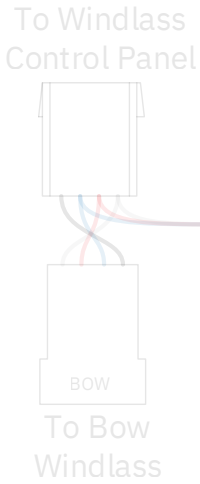



# Technical Wiring Diagram



RCT-21(U/E)

**IMPORTANT**  
Cables/wires must be cable tied well.

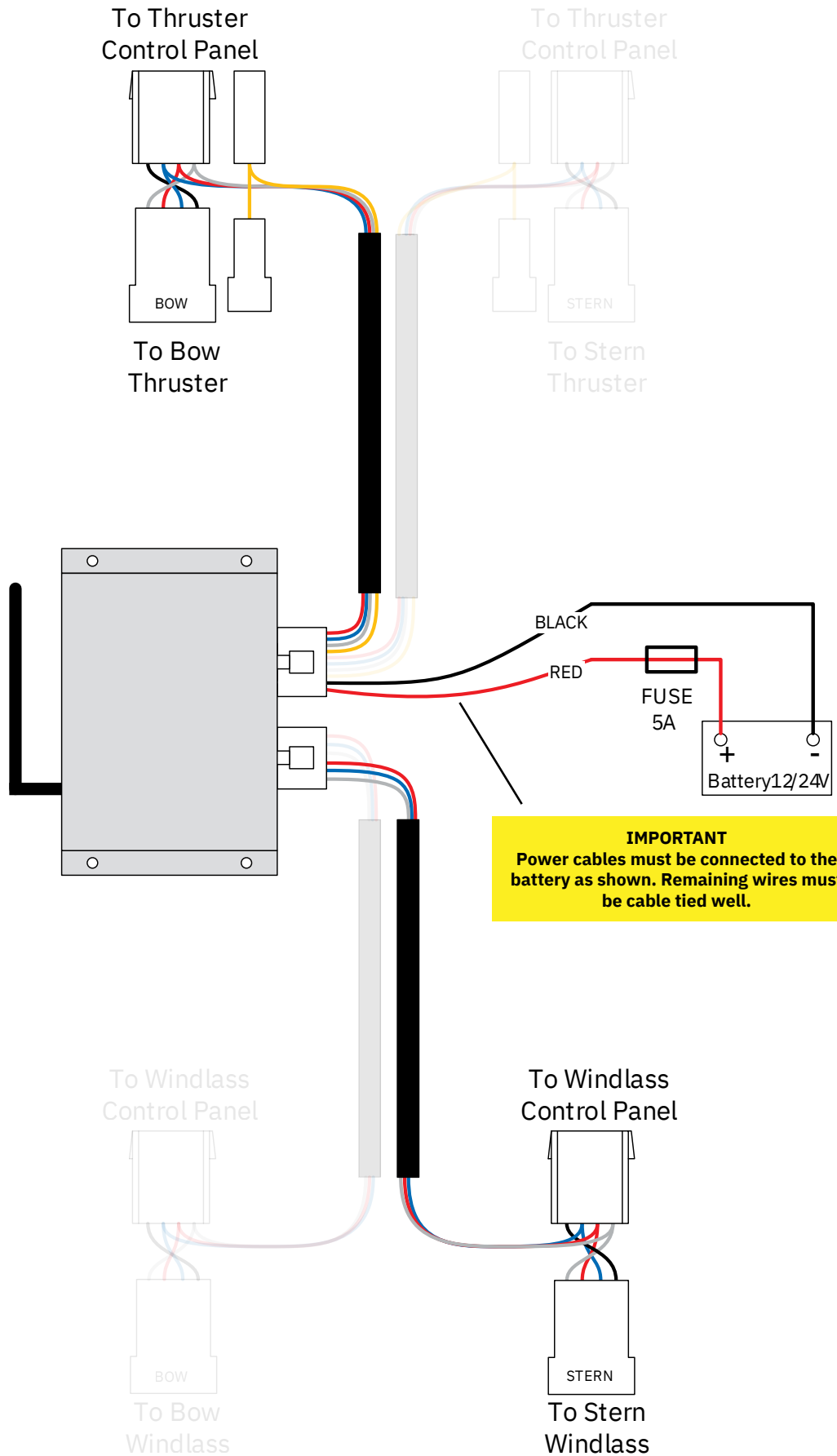

**IMPORTANT**  
Power cables must be connected to the battery as shown. Remaining wires must be cable tied well.

# Technical Wiring Diagram



**RCT-22(U/E)**

**IMPORTANT**  
Cables/wires must be cable tied well.

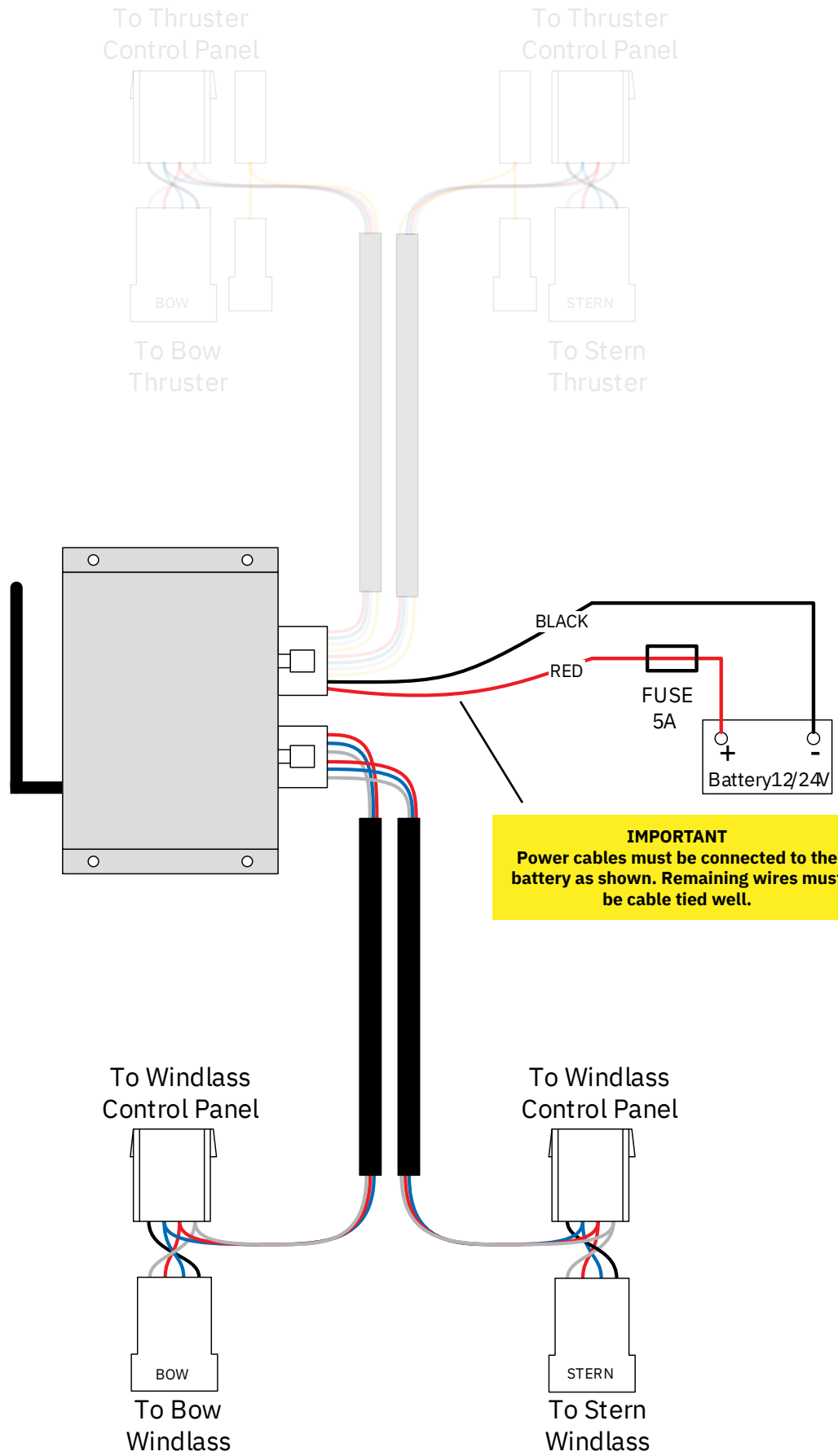

**IMPORTANT**  
Power cables must be connected to the battery as shown. Remaining wires must be cable tied well.

# Technical Wiring Diagram



**RCT-23(U/E)**

**IMPORTANT**  
Cables/wires must be cable tied well.

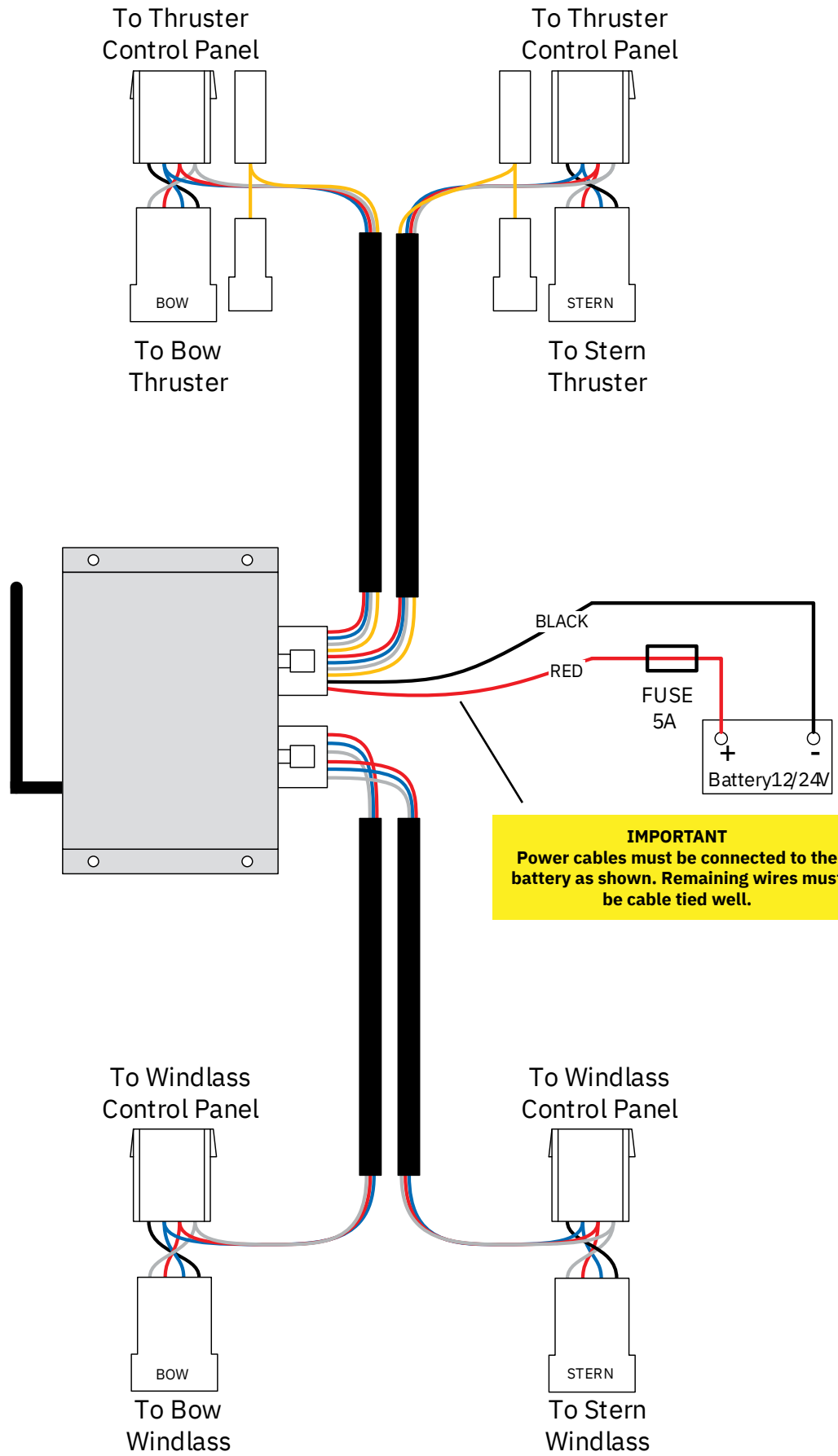

**IMPORTANT**  
Power cables must be connected to the battery as shown. Remaining wires must be cable tied well.

# Output Signals Diagram

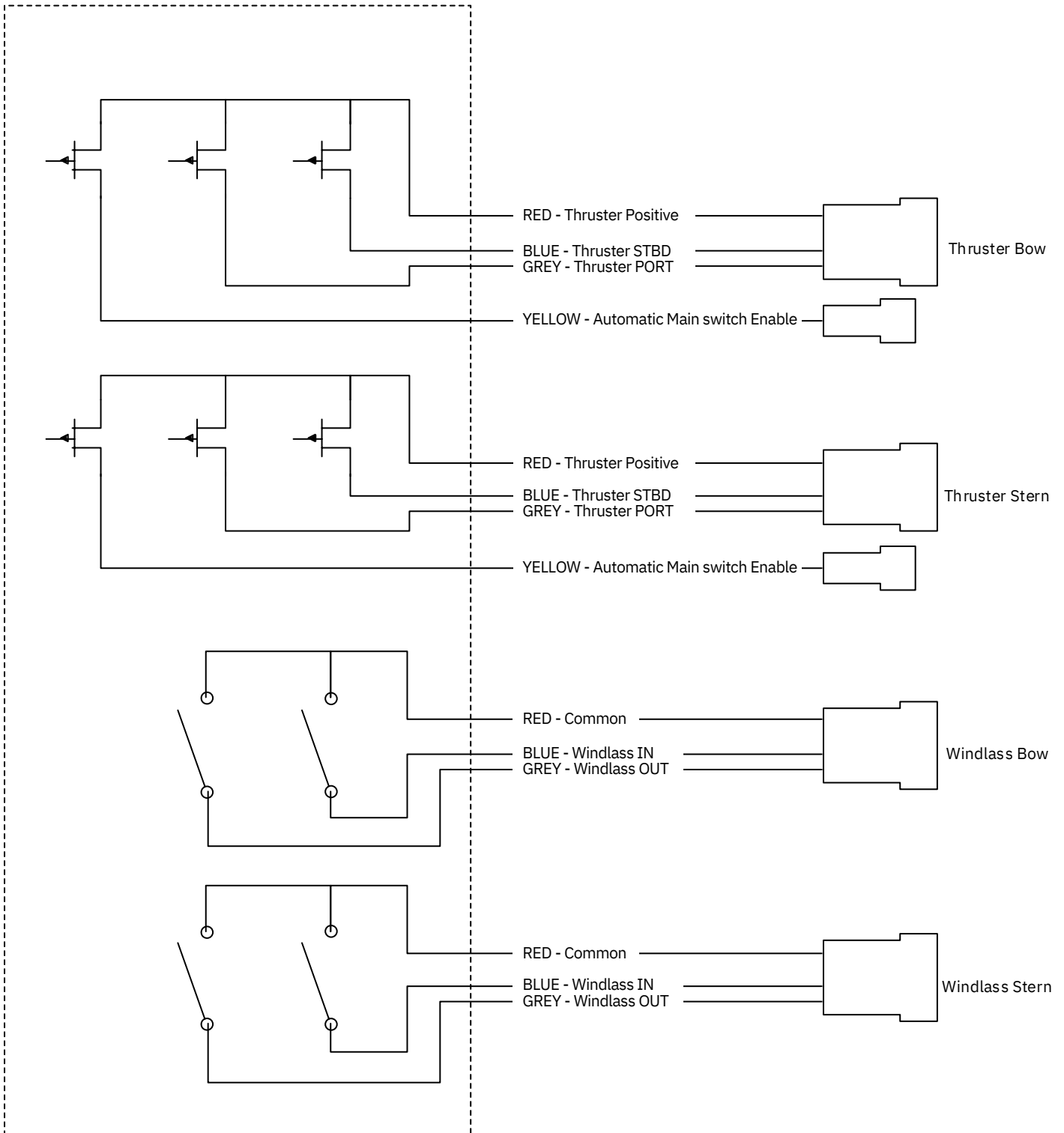

S-Link is a CAN-based control system used for communication between Sleipner products installed on a vessel. The system uses BACKBONE Cables as a common power and communication bus with separate SPUR Cables to each connected unit. Units with low power consumption are powered directly from the S-Link bus therefore one power cable must be connected to the BACKBONE Cable through a T-Connector.

**Main advantages of S-Link system:**

- Compact and waterproof plugs.
- BACKBONE and SPUR Cables have different colour coding and keying to ensure correct and easy installation. BACKBONE Cables have blue connectors and SPUR Cables have green connectors.
- Different cable lengths and BACKBONE Extenders makes the system scalable and flexible to install.



**Installation of S-Link cables:**

Select appropriate cables to keep the length of BACKBONE- and SPUR Cables to a minimum. In case of planned installation with total BACKBONE Cable length exceeding 100 meters please consult your local distributor. The S-Link cables should be properly fastened when installed to avoid sharp bend radius, cable chafing and undesired strain on connectors. Locking mechanism on connectors must be fully closed. To ensure long lifetime, cables, T-Connectors and Extenders should not be located so that they are permanently immersed in water or other fluids. It is also recommended to install cables such that water and condensation do not run along the cables and into the connectors.

The POWER Cable should ideally be connected around the middle of the BACKBONE Cable to ensure an equal voltage drop at each end of the BACKBONE Cable. The yellow and black wire in the POWER Cable shall be connected to GND and the red wire connected to +12VDC or +24VDC.

To reduce the risk of interference, avoid routing the S-Link cables close to equipment such as radio transmitters, antennas or high voltage cables. The backbone must be terminated at each end with the END Terminator.

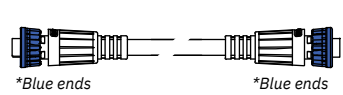
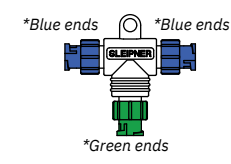
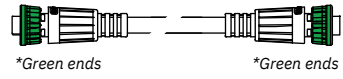
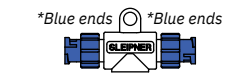
SPUR cables can be left unterminated to prepare for the installation of future additional equipment. In such cases, ensure to protect open connectors from water and moisture to avoid corrosion in the connectors.

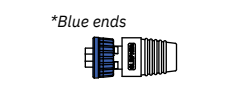
|   |  |   |   |
|---|--|---|---|
|  <p>*Blue ends</p>    | <p><b>BACKBONE Cable</b><br/>Forms the communication and power bus throughout a vessel. Available in different standard lengths.</p>   |  <p>*Blue ends<br/>*Green ends</p> | <p><b>T-Connector</b><br/>Used for connection of SPUR or POWER Cable to the BACKBONE Cable. One T-Connector for each connected cable.</p> |
|  <p>*Green ends</p> | <p><b>SPUR Cable</b><br/>Used to connect S-Link compliant products to the backbone cable. One SPUR Cable must be used for each connected component, with no exceptions. Recommended to be as short as practically possible. Available in different standard lengths.</p> |  <p>*Blue ends</p>                | <p><b>BACKBONE Extender</b><br/>Connects two BACKBONE Cables to extend the length.</p>  |
|  <p>*Green ends</p> | <p><b>POWER Cable</b><br/>Required in all installations for connection of BACKBONE Cable to a power supply. It shall not be more than one POWER Cable in an installation.</p>  |  <p>*Blue ends</p>                | <p><b>END Terminator</b><br/>Must be one at each end of the BACKBONE bus.</p>   |

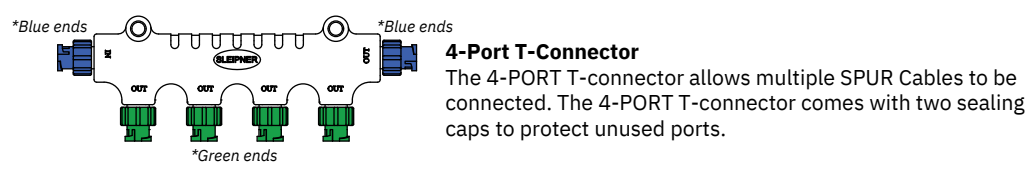

**S-Link installation example**

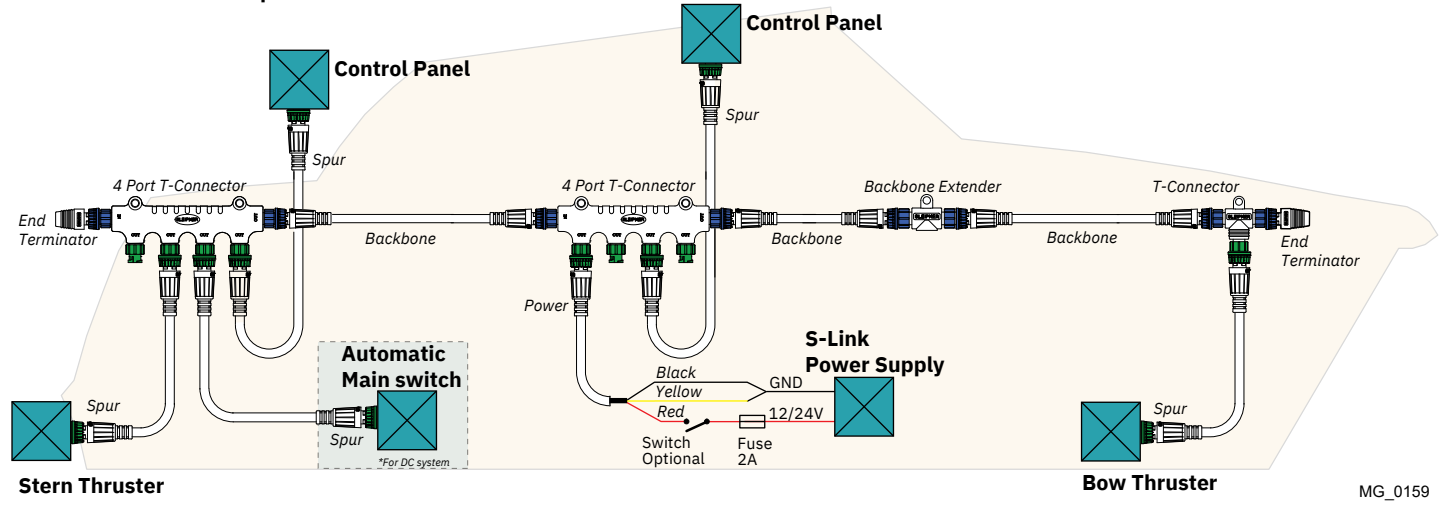

# Technical Wiring Diagram

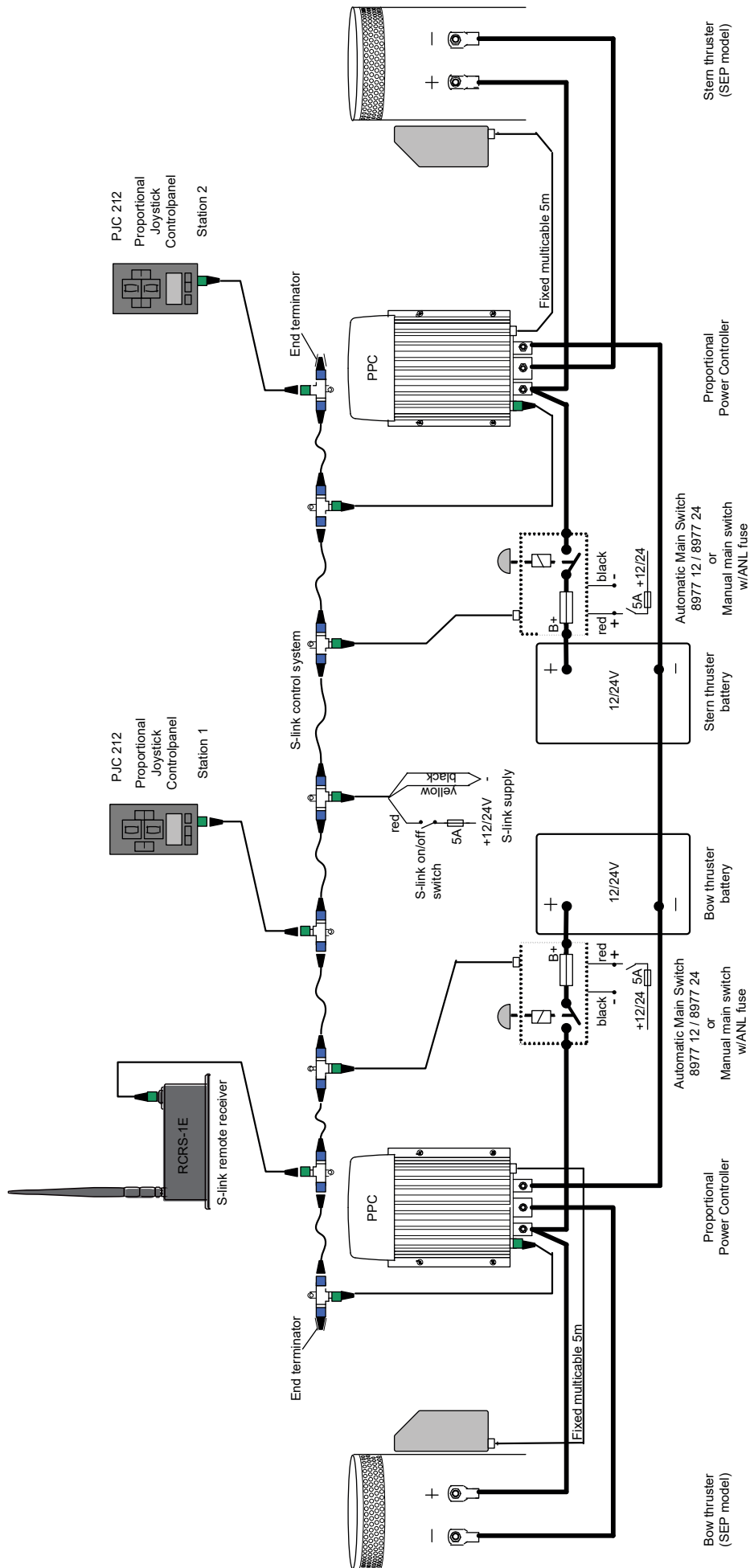

**Observe PPC battery terminal polarity !**

**Find your local professional dealer from our certified worldwide network for expert service and support. visit our website [www.sleipnergrouper.com/support](http://www.sleipnergrouper.com/support)**

## Product Spare Parts and Additional Resources

**For additional supporting documentation, we advise you to visit our website [www.sleipnergrouper.com](http://www.sleipnergrouper.com) and find your Sleipner product.**

## Warranty statement

1. Sleipner Motor AS (The "Warrantor") warrants that the equipment (parts, materials, and embedded software of products) manufactured by the Warrantor is free from defects in workmanship and materials for purpose for which the equipment is intended and under normal use and maintenance service (the "Warranty").
2. This Warranty is in effect for two years (Leisure Use) or one year (Commercial and other Non-leisure Use) from the date of delivery/purchase by the end user, with the following exceptions;
  - (a) For demonstration vessels, or vessels kept on the water, the dealer is considered as the end user from 6 months after their launch of the vessel;
  - (b) The warranty period starts no later than 18 months after the first launch of the vessel.
 Please note that the boat manufacturer and dealer must pay particular attention to correct maintenance and service both by the products manuals as well as general good practice for the location the boat is kept in the period the boat is in their care. In cases where the 6 and 18 months grace periods for boat builders and dealers are passed, it is possible to obtain a full warranty upon inspection and approval of the warrantor or such representative.
3. Certain parts, classified as wearable or service parts, are not covered by the warranty. A failure to follow the required maintenance and service work as described in the product manual render all warranty on parts or components directly or indirectly affected by this void. Please also note that for some parts, time is also a factor separately from actual operational hours.
4. This Warranty is transferable and covers the equipment for the specified warranty period.
5. The warranty does not apply to defects or damages caused by faulty installation or hook-up, abuse or misuse of the equipment including exposure to excessive heat, salt or fresh water spray, or water immersion except for equipment specifically designed as waterproof.
6. In case the equipment seems to be defective, the warranty holder (the "Claimant") must do the following to make a claim:
  - (a) Contact the dealer or service centre where the equipment was purchased and make the claim. Alternatively, the Claimant can make the claim to a dealer or service centre found at [www.sleipnergrouper.com](http://www.sleipnergrouper.com). The Claimant must present a detailed written statement of the nature and circumstances of the defect, to the best of the Claimant's knowledge, including product identification and serial nbr., the date and place of purchase and the name and address of the installer. Proof of purchase date should be included with the claim, to verify that the warranty period has not expired;
  - (b) Make the equipment available for troubleshooting and repair, with direct and workable access, including dismantling of furnishings or similar, if any, either at the premises of the Warrantor or an authorised service representative approved by the Warrantor. Equipment can only be returned to the Warrantor or an authorised service representative for repair following a pre-approval by the Warrantor's Help Desk and if so, with the Return Authorisation Number visible postage/shipping prepaid and at the expense of the Claimant.
7. Examination and handling of the warranty claim:
  - (a) If upon the Warrantor's or authorised service Representative's examination, the defect is determined to result from defective material or workmanship in the warranty period, the equipment will be repaired or replaced at the Warrantor's option without charge, and returned to the Purchaser at the Warrantor's expense. If, on the other hand, the claim is determined to result from circumstances such as described in section 4 above or a result of wear and tear exceeding that for which the equipment is intended (e.g. commercial use of equipment intended for leisure use), the costs for the troubleshooting and repair shall be borne by the Claimant;
  - (b) No refund of the purchase price will be granted to the Claimant, unless the Warrantor is unable to remedy the defect after having a reasonable number of opportunities to do so. In the event that attempts to remedy the defect have failed, the Claimant may claim a refund of the purchase price, provided that the Claimant submits a statement in writing from a professional boating equipment supplier that the installation instructions of the Installation and Operation Manual have been complied with and that the defect remains.
8. Warranty service shall be performed only by the Warrantor, or an authorised service representative, and any attempt to remedy the defect by anyone else shall render this warranty void.
9. No other warranty is given beyond those described above, implied or otherwise, including any implied warranty of merchantability, fitness for a particular purpose other than the purpose for which the equipment is intended, and any other obligations on the part of the Warrantor or its employees and representatives.
10. There shall be no responsibility or liability whatsoever on the part of the Warrantor or its employees and representatives based on this Warranty for injury to any person or persons, or damage to property, loss of income or profit, or any other incidental, consequential or resulting damage or cost claimed to have been incurred through the use or sale of the equipment, including any possible failure or malfunction of the equipment or damages arising from collision with other vessels or objects.
11. This warranty gives you specific legal rights, and you may also have other rights which vary from country to country.

## Patents

At Sleipner we continually reinvest to develop and offer the latest technology in marine advancements. To see the many unique designs we have patented visit our website [www.sleipnergrouper.com/patents](http://www.sleipnergrouper.com/patents)

# UK Declaration of conformity (DoC)

|  |  |   |
|--|--|---|
| We, The Manufacturer:  | <b>Sleipner Motor AS</b><br>Arne Svendsens gate 6-8, NO 1612 Fredrikstad, Norway |   |
| With ISO 9001 certificate:   | 1484-2007-AQ-NOR-NA, issued by DNV-GL  |   |
| Declare that the product:<br><b>Product Description:</b> Remote control kit<br><b>Model Numbers:</b><br>RC-20E containing RCT-20E and RCR-2E<br>RC-21E containing RCT-21E and RCR-2E<br>RC-22E containing RCT-22E and RCR-2E<br>RC-23E containing RCT-23E and RCR-2E<br>RCS-20E containing RCT-20E and RCRS-2E   |  |   |
| Subject to installation, maintenance and use conforming to their intended purpose, is in conformity with the provisions of the following UK Regulations:<br><ul style="list-style-type: none"> <li>• Radio Equipment Regulations 2017</li> <li>• The Restriction of the Use of Certain Hazardous Substances in Electrical and Electronic Equipment Regulations - 2012</li> </ul> |  |   |
| The product is tested to meet the standards and criteria outlined in:  | <b>Radio</b>   | EN 300 220-1 V3.1.1:2017<br>EN 300 220-2 V3.1.1:2017                                    |
|  | <b>EMC</b>   | EN 60945:2002<br>IEC 60533:2015<br>EN 301 489-1 V2.2.0:2017<br>EN 301 489-3 V2.2.0:2017 |
|  | <b>Safety</b>  | EN 62368-1:2020   |
|  | <b>RoHS</b>  | EN 63000:2018   |

This declaration of conformity is issued under the exclusive responsibility of the manufacturer.

Fredrikstad, 19th of January 2022

Ronny Skauen, President and CEO

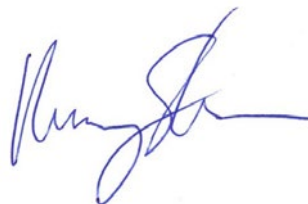



# CE Declaration of conformity (DoC)

|   |  |   |
|---|--|---|
| We, The Manufacturer:   | <b>Sleipner Motor AS</b><br>Arne Svendsens gate 6-8, NO 1612 Fredrikstad, Norway |   |
| With ISO 9001 certificate:  | 1484-2007-AQ-NOR-NA, issued by DNV-GL  |   |
| Declare that the product:<br><b>Product Description:</b> Remote control kit<br><b>Model Numbers:</b><br>RC-20E containing RCT-20E and RCR-2E<br>RC-21E containing RCT-21E and RCR-2E<br>RC-22E containing RCT-22E and RCR-2E<br>RC-23E containing RCT-23E and RCR-2E<br>RCS-20E containing RCT-20E and RCRS-2E  |  |   |
| Subject to installation, maintenance and use conforming to their intended purpose, is in conformity with the provisions of the following EU Directives: <ul style="list-style-type: none"> <li>• Radio equipment - Directive 2014/53/EU</li> <li>• Restriction of the Use of certain Hazardous Substances in Electrical and Electronic Equipment (RoHS) - Directive 2002/95/EC</li> </ul> |  |   |
| The product is tested to meet the standards and criteria outlined in:   | <b>Radio</b>   | EN 300 220-1 V3.1.1:2017<br>EN 300 220-2 V3.1.1:2017                                    |
|   | <b>EMC</b>   | EN 60945:2002<br>IEC 60533:2015<br>EN 301 489-1 V2.2.0:2017<br>EN 301 489-3 V2.2.0:2017 |
|   | <b>Safety</b>  | EN 62368-1:2020   |
|   | <b>RoHS</b>  | EN 63000:2018   |

This declaration of conformity is issued under the exclusive responsibility of the manufacturer.

Fredrikstad, 19th of January 2022

Ronny Skauen, President and CEO

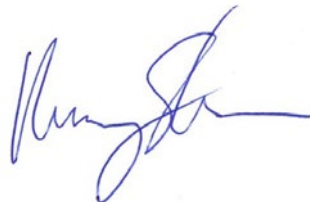

© **Sleipner Group**, All rights reserved  
The information given in the document  
was right at the time it was published.  
However, Sleipner Group cannot  
accept liability for any inaccuracies or  
omissions it may contain. Continuous  
product improvement may change the  
product specifications without notice.  
Therefore, Sleipner Group cannot accept  
liability for any possible differences  
between product and document.

**Register your product and learn more  
at [www.sleipnergroun.com](http://www.sleipnergroun.com)**



**SLEIPNER GROUP**

P.O. Box 519

N-1612 Fredrikstad

Norway

[www.sleipnergroun.com](http://www.sleipnergroun.com)

Made in Norway

